

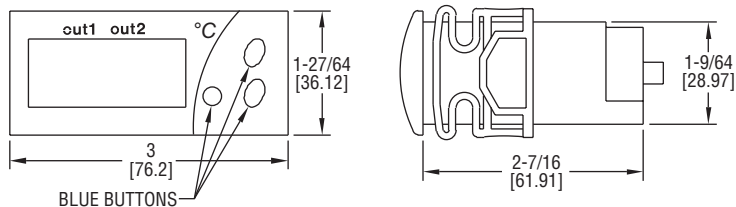

# Series TSS2 Dual Stage Temperature Switch

## Specifications - Installation and Operating Instructions



WIRING DIAGRAM

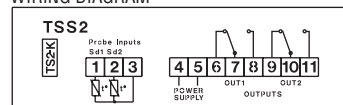

The TSS2 is an electronic temperature controller designed for ON/OFF control or Neutral Area Control. They can be provided with 1 or 2 probes (PTC or NTC) according to parameter P5 and it provides two output relays plus an alarm buzzer. The unit controls cooling, heating or both, since its relays can be setup for direct or reverse operation. The user is able to program 34 different parameters including set points, hysteresis, configuration of alarms and probe adjustment using the silicone front keypad. The unit features error warning and password protection.

Each suffix can take the following values:

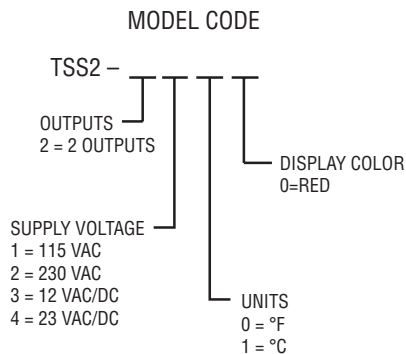

**Note:** Unit must be mounted away from vibration, impacts, water and corrosive gases.

- Cut hole in panel 71 x 29 mm (2.80 x 1.14 inches).
- Apply silicone (or rubber gasket) around the perimeter of the hole to prevent leakage.
- Insert unit into hole of panel.
- Slide removable fitting clips onto unit from the back until secure to panel.
- Wiring diagram is displayed on the top of the unit.
- **Note:** DO NOT INSTALL PROBE CABLE NEAR POWER CABLES.

### SPECIFICATIONS

- Probe Range:**  
 PTC: -58 to 302°F (-50 to 150°C);  
 NTC: -58 to 230°F (-50 to 110°C).
- Input:**  
 PTC: 1000Ω @ 25°C;  
 NTC: 10 kΩ @ 25°C.
- Outputs:** OUT1 - SPDT relay rated 16A @ 240 VAC resistive; OUT2 - SPDT relay rated 8A @ 240 VAC resistive.
- Horsepower Rating (HP):** 1 HP (OUT1).
- Power Requirements:** 115 VAC, 230 VAC, 12 VAC/VDC or 24 VAC/VDC (depending on model).
- Accuracy:** 1% FS.
- Display:** 3-digit and sign, red LED.
- Resolution:** 0.1° (<100°); 1° (≥100°).
- Memory Backup:** Nonvolatile memory.
- Temperature Limit:** Ambient: 32 to 158°F (0 to 70°C).
- Storage Temperature:** -4 to 176°F (-20 to 80°C).
- Dimensions:** 3 x 1-27/64 x 2-7/16 in.
- Front Panel Rating:** IP64.
- Weight:** 2.3 oz (65 g).
- Agency Approvals:** CE, cURus.

### Maintenance, cleaning and repair

After final installation of the unit, no routine maintenance is required. Clean the surface of the display controller with a soft and damp cloth. Never use abrasive detergents, petrol, alcohol or solvents. All repairs must be made by authorized personnel.

## List of parameters

Parameter	Description	Units	Range
SP1	Set Point 1	Degrees	r4 to r6
SP2	Set Point 2	Degrees	r5 to r7
r0	Dependency SP1-SP2	Range	ind/dep
r1	Differential for SP1	Degrees	0.1 to 20.0
r2	Differential for SP2	Degrees	0.1 to 20.0
r3	Band differential	Degrees	0.1 to 20.0
r4	Lowest value for SP1	Degrees	-99.9 to r6
r5	Lowest value for SP2	Degrees	-99.9 to r7
r6	Highest value for SP1	Degrees	r4 to 302
r7	Highest value for SP2	Degrees	r5 to 302
r8	Regulation or operating mode	Range	On1/On2/nEU
A0	Alarm differential	Degrees	0.1 to 20.0
A1	Maximum alarm probe 1 (1)	Degrees	0.1 to 99.9
A2	Maximum alarm probe 2 (2)	Degrees	0.1 to 99.9
A3	Minimum alarm probe 1 (1)	Degrees	0.1 to 99.9
A4	Minimum alarm probe 2 (2)	Degrees	0.1 to 99.9
A5	Alarm verification time	h-m (*)	0.0 to 18.0
A6	Alarm probe 1 selection	Range	AHL/Ano/AH/AL
A7	Alarm probe 2 selection	Range	AHL/Ano/AH/AL
c0	Minimum relay stop time	Minutes	0 to 240
c1	Operation relay 1	Range	dir/inv
c2	Operation relay 2	Range	dir/inv
c3	Default operation relay 1	Range	Opn/Clo
c4	Default operation relay 2	Range	Opn/Clo
P0	Temperature scale selection	Range	°C/°F
P1	Calibration of probe 1	Degrees	-20.0 to 20.0
P2	Calibration of probe 2	Degrees	-20.0 to 20.0
P3	Decimal point	Range	no/yes
P4	Probe to be displayed	Range	sd1/sd2
P5	Number of probes	Range	1/2
H0	Reprogramming	Range	0
H1	Keyboard protection	Range	no/yes
H2	Operation LED OUT1	Range	dir/inv
H3	Operation LED OUT2	Range	dir/inv
H4	Address for serial communication	Numeric	0 to 999
H5	Access code to parameters	Numeric	0 to 999
H6	Probe type	Range	Ptc/Ntc

(\*)h-m are data in format XX.Y where XX are hours and Y tens of minutes.

(1)referred to set 1.

(2)referred to set 2.

## Parameter descriptions

**SP1** = Operation order of relay 1. Specifies the ON/OFF point of relay 1. Variable between r4 and r6.

**SP2** = Operation order of relay 2. Specifies the ON/OFF point of relay 2. Variable between r5 and r7.

**r0** = Dependency between SP1 and SP2. Only for mode ONOFF1

ind = order for relay 2, SP2.

dep = order for relay 2, SP1+SP2.

**r1** = Differential or hysteresis for relay 1. Temperature differential between ON/OFF of relay 1 in ON/OFF control.

**r2** = Differential or hysteresis for relay 2. Temperature differential between ON/OFF of relay 2 in ON/OFF control.

**r3** = Band differential. Temperature differential between ON/OFF of relays 1 and 2 in neutral area control. For relay 1 it is added to SP1 and for relay 2 it is subtracted from SP1.

**r4** = Lowest value for SP1.

**r5** = Lowest value for SP2.

**r6** = Highest value for SP1.

**r7** = Highest value for SP2.

**r8** = Regulation or operating mode. Selection of the operating mode.

**A0** = Alarm differential. It is the temperature differential between the alarm On and Off cycle.

**A1** = Maximum alarm probe1.

**A2** = Maximum alarm probe2.

Maximum alarm ON when probe 2 higher than SP2+A2

Maximum alarm OFF when probe 2 lower than SP2+A2-A0.

**A3** = Minimum alarm probe1.

Minimum alarm ON when probe 1 lower than SP1-A3

Minimum alarm OFF when probe 1 higher than SP1-A3+A0.

**A4** = Minimum alarm probe2.

Minimum alarm ON when probe 2 lower than SP2-A4

Minimum alarm OFF when probe 2 higher than SP2-A4+A0.

**A5** = Alarm verification time. Time from the alarm event until it trips.

**A6** = Alarm probe 1 selection.

AHL=Maximum and minimum alarm probe 1 enabled.

Ano=No alarms probe 1.

AH=Maximum alarm probe 1 enabled.

AL=Minimum alarm probe 1 enabled.

**A7** = Alarm probe 2 selection.

AHL=Maximum and minimum alarm probe 2 enabled.

Ano=No alarms probe 2.

AH=Maximum alarm probe 2 enabled.

AL=Minimum alarm probe 2 enabled.

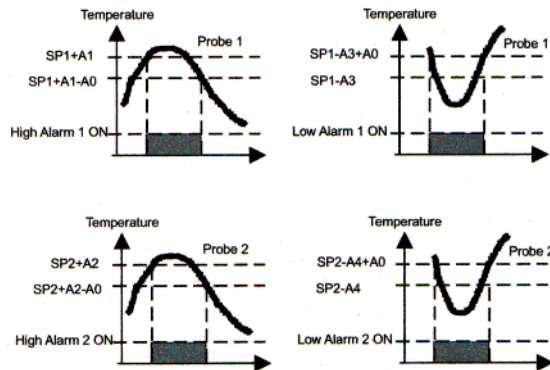

**c0** = Minimum relay stop time. Minimum time from the disconnection of a relay until it can be switched on again.

**c1** = Operation relay 1. Selection between direct or reverse operation for relay 1.

**c2** = Operation relay 2. Selection between direct or reverse operation for relay 2.

**c3** = Default operation relay 1. In case of failure of probe 1:

oPn= relay 1 will remain open.

Clo= relay 1 will remain closed.

**c4** = Default operation relay 2. In case of failure of probe 1 (for all modes excepting ON OFF2) or in case of failure of probe 2 (for mode ON OFF2):

oPn= relay 2 will remain open.

Clo= relay 2 will remain closed.

**P0** = Temperature scale selection.

**P1** = Calibration of probe 1. Offset degrees to be added to probe 1.

**P2** = Calibration of probe 2. Offset degrees to be added to probe 2.

**P3** = Decimal point. If the displayed value of the probes is desired with decimals or not.

**P4** = Probe to be displayed. Probe always on the display. The other probe can be seen pressing the keys SET+UP.

sd1= probe 1.

sd2= probe 2.

**P5** = Number of probes. If P5=1, there is not ON OFF2 mode. If selected, it will operate as ONOFF1.

**H0** = Reprogramming. Parameter to reprogram the thermostat.

**H1** = Keyboard protection.

To change the sets, enter into parameter and exit again. The protection setting is momentarily released. It switches on again 1 minute after the last time a key was pressed.

Yes= Keyboard Protected.

No=Keyboard non protected.

**H2** = Operation of LED OUT1.

dir = On when relay 1 is ON.

inv = On when relay 1 is OFF.

**H3** = Operation of LED OUT2.

dir = On when relay 2 is ON.

inv = On when relay 2 is OFF.

**H4** = Serial communication address. Address for computer connection.

**H5** = Parameter entry code. Factory set as 0.

**H6** = Input probe type selectable between PTC or NTC.

### Message display

Under normal operation, the temperature of the probe selected by P4 will be displayed, the following messages may also appear:

- Err** Memory reading error.
- ErP** Error of the probe not shown on the display.
- AH1** Maximum temperature alarm, probe 1.
- AL1** Minimum temperature alarm, probe 1.
- AH2** Maximum temperature alarm, probe 2.
- AL2** Minimum temperature alarm, probe 2.
- ooo** Open probe.
- **---** Shorted probe.

Pressing SET with UP it displays the probe not selected by P4.

When the probe not selected by P4 is displayed, it alternates its value with message Sd1 or Sd2 depending if it is probe 1 or probe 2.

The display blinks when waiting for a value confirmation.

### LED indications

**Out1:** Indicates relay 1 On or Off as per parameter H2. If H2=dir, with relay 1 On, LED lit, if H2=inv, with relay 1 On, LED off. It blinks when SP1 is displayed.

**Out2:** Indicates relay 2 On or Off as per parameter H3. If H3=dir, with relay 2 On, LED lit, if H3=inv, with relay 2 On, LED off. It blinks when SP2 is displayed.

### Setting SP1 and SP2

- Press and release SET. The current value of order 1 is displayed. SP1 and led OUT1 blink.
- Press UP or DOWN to increase or decrease the value.
- Press SET to confirm the new value. The actual value of order 2 will be displayed, SP2 and LED OUT2 blink.
- Press UP or DOWN to increase or decrease the value.
- Press SET to confirm the new value and exit.

### Parameter setup

- Press SET for 8 seconds. Value 0 will blink.
- With UP and DOWN input the code (factory set as 0).
- Press SET to confirm the code. If correct, the label of the first parameter will be displayed.
- With UP or DOWN go to the desired parameter in the parameter list.
- Press SET to see the value.
- With UP or DOWN change the value to the new value as desired.
- Press SET to confirm and exit again to the parameter list. (Also to exit to the list without parameter modification.)
- Press SET + DOWN to exit setup or wait for 1 minute.

### Resetting the keyboard code

You can setup to 0 the keyboard code switching the unit off and on while pressing the SET key.

### Buzzer disconnection

Pressing SET with DOWN turns off the buzzer alarm. The message of alarm continue appearing in the display.

### Reprogramming factory values (H0)

•Access to parameter H0 as explained in parameter setup.

•Value 0 will be displayed.

•Press SET for 8 seconds. Pro will be displayed if they have been setup correctly.

•Press SET + DOWN to exit setup or wait for 1 minute.

	Description	Factory value
SP1	Set Point 1	10.0
SP2	Set Point 2	10.0
r0	Dependency SP1 - SP2	ind
r1	Differential for SP1	1.0
r2	Differential for SP2	1.0
r3	Band differential 1.0	1.0
r4	Lower value for SP1	-99.9
r5	Lower value for SP2	-99.9
r6	Higher value for SP1	99.9
r7	Higher value for SP2	99.9
r8	Regulation or operating mode	On1
A0	Alarm differential	0.1
A1	Maximum alarm probe 1	99.9
A2	Maximum alarm probe 2	99.9
A3	Minimum alarm probe 1	99.9
A4	Minimum alarm probe 2	99.9
A5	Alarm verification time	18.0
A6	Alarm probe 1 selection	AHL
A7	Alarm probe 2 selection	AHL
c0	Minimum relay stop time	0
c1	Operation relay 1	dir
c2	Operation relay 2	dir
c3	Default operation relay 1	Opn
c4	Default operation relay 2	Opn
P0	Temperature scale selection	°C
P1	Calibration of probe 1	0.0
P2	Calibration of probe 2	0.0
P3	Decimal point	yes
P4	Probe to be displayed	sd1
P5	Number of probes	2
H0	Reprogramming	0
H1	Keyboard protection	no
H2	Operation LED OUT1	dir
H3	Operation LED OUT2	dir
H4	Address for serial communication	0
H5	Access code to parameters	0
H6	Probe type	Ptc

**Operating modes**

**Mode ON OFF1 (On1) with r0=ind.**

Relay 1 with c1=dir.

Temperature of probe 1  $\geq$  SP1+r1 -->relay 1 ON  
 Temperature of probe 1  $\leq$  SP1 -->relay 1 OFF

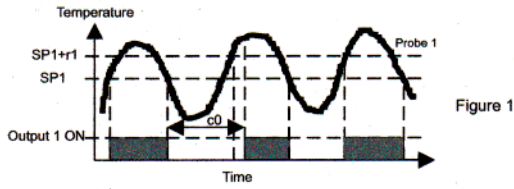

Relay 1 with c1=inv.

Temperature of probe 1  $\leq$  SP1-r1 -->relay 1 ON  
 Temperature of probe 1  $\geq$  SP1 -->relay 1 OFF

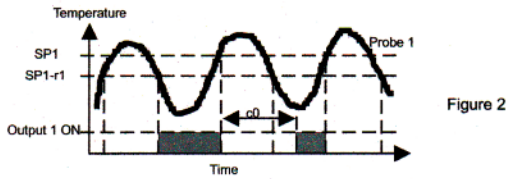

Relay 2 with c2=dir.

Temperature of probe 1  $\geq$  SP2+r2 -->relay 2 ON  
 Temperature of probe 1  $\leq$  SP2 -->relay 2 OFF

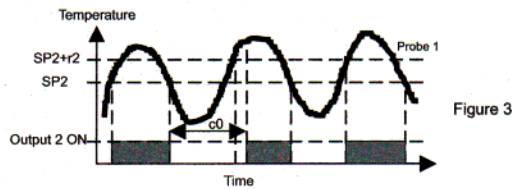

Relay 2 with c2=inv.

Temperature of probe 1  $\leq$  SP2-r2 -->relay 2 ON  
 Temperature of probe 1  $\geq$  SP2 -->relay 2 OFF

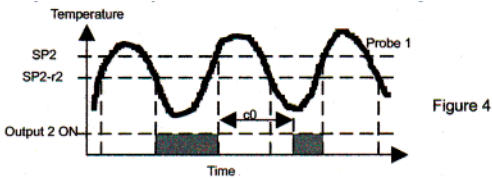

**Mode ON OFF1 (On1) with r0=dep.**

Output 1 works as in independent ON/OFF control (Figure 1 and 2), but output 2 works as follows:

Relay 2 with c2=dir.

Temperature of probe 1  $\geq$  SP1+SP2+r2 -->relay 2 ON  
 Temperature of probe 1  $\leq$  SP1+SP2 -->relay 2 OFF

Relay 2 with c2=inv.

Temperature of probe 1  $\leq$  SP1+SP2-r2 -->relay 2 ON  
 Temperature of probe 1  $\geq$  SP1+SP2 -->relay 2 OFF

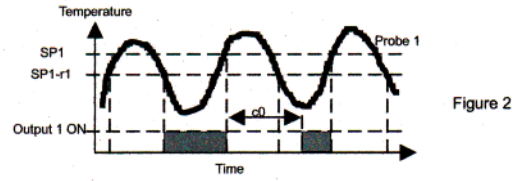

**Mode ON OFF2 (On2)**

Output 1 works as in independent ON/OFF control (Figure 1 and 2), but output 2 works as follows:

Relay 2 with c2=dir.

Temperature of probe 2  $\geq$  SP2+r2 -->relay 2 ON  
 Temperature of probe 2  $\leq$  SP2 -->relay 2 OFF

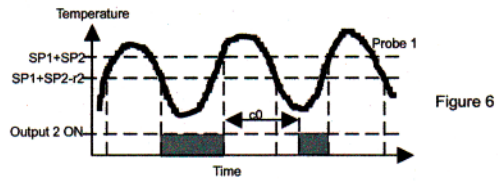

Relay 2 with c2=inv.

Temperature of probe 2  $\leq$  SP2-r2 -->relay 2 ON  
 Temperature of probe 2  $\geq$  SP2 -->relay 2 OFF

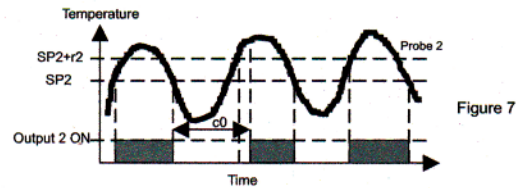

**Neutral Area Mode (nEU)**

Relay 1

Temperature of probe 1  $\geq$  SP1+r3 -->relay 2 ON  
 Temperature of probe 1  $\leq$  SP1 -->relay 2 OFF

Relay 2

Temperature of probe 1  $\leq$  SP1-r3 -->relay 2 ON  
 Temperature of probe 1  $\geq$  SP1 -->relay 2 OFF

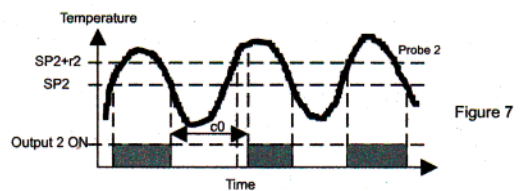

**Operation in case of error.**

If probe 1 fails, the operation is through c3. (See Parameter description.)

If probe 2 fails, the operation is through c4. (See Parameter description.)

In case of memory failure, both relays will remain open.